

Similar triangles

1 For each case, identify the geometric statement which allows you to conclude that the two triangles are similar.

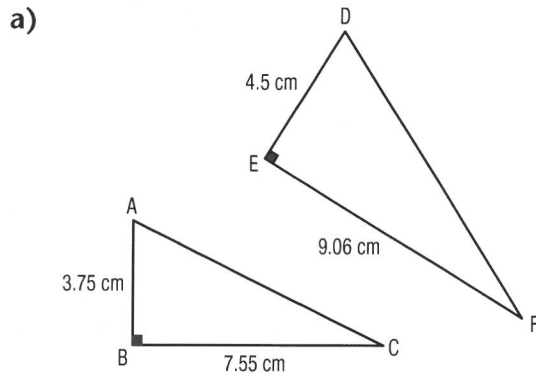

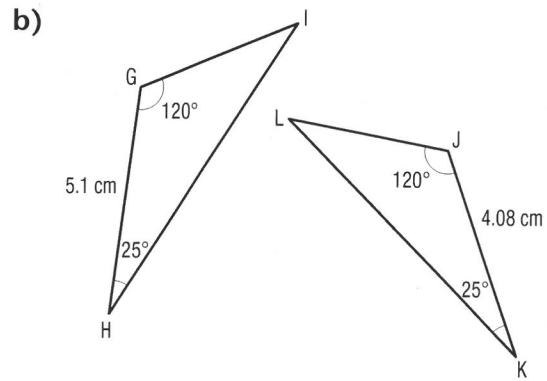

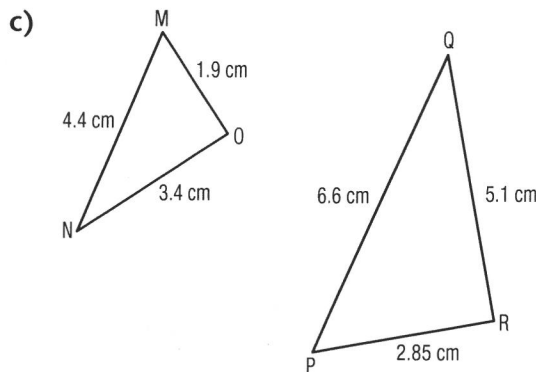

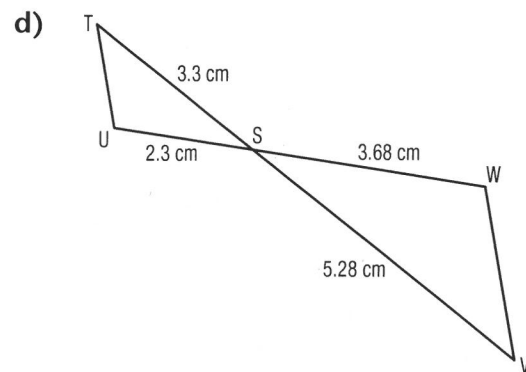

2 Among the following pairs of triangles, identify which pairs are similar.

(A)

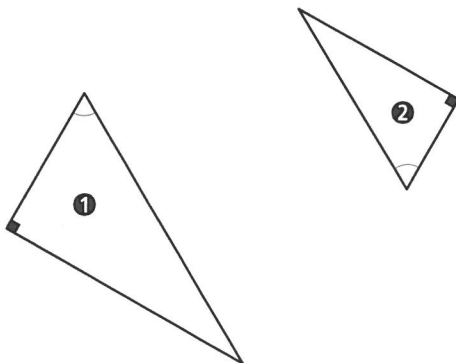

(B)

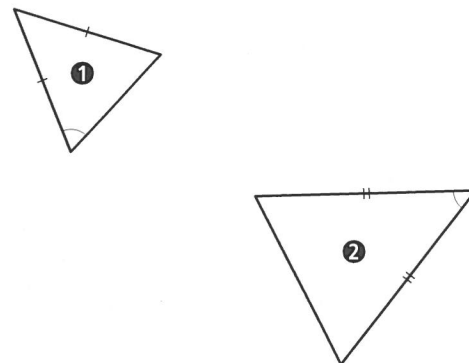

Name: _____

Group: _____ Date: _____

(cont'd)

C

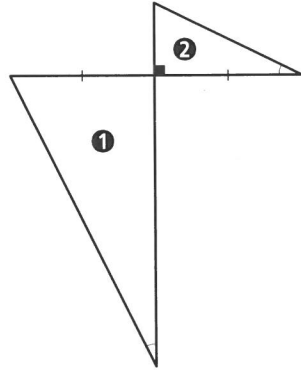

D

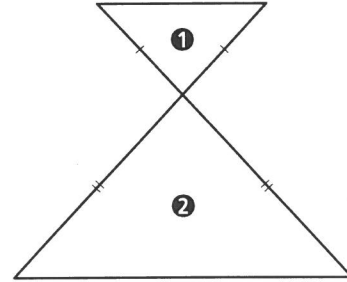

3 For each case, identify the missing value.

a)

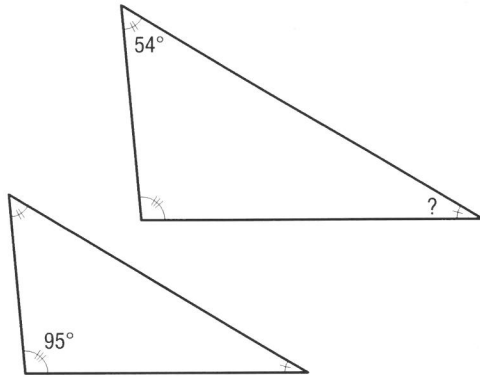

b)

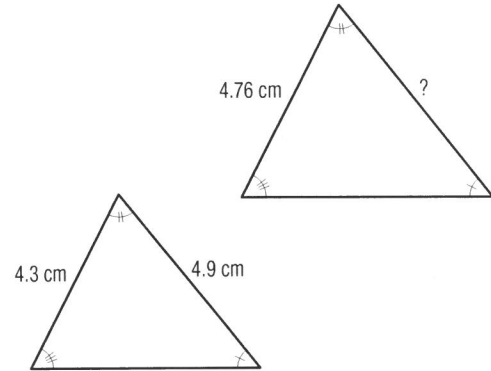

c) $d_1 \parallel d_2 \parallel d_3$

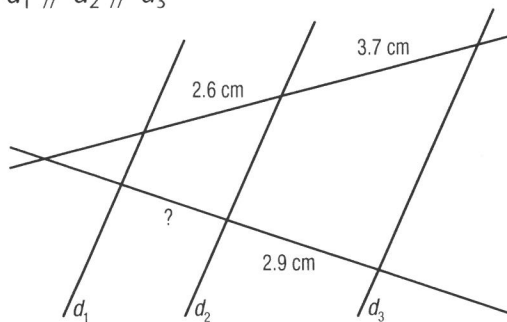

d)

